

## Grounding Kit Ecoflex 15 / Item No.: 6813



The grounding clamp for 10 mm coax cables such as Ecoflex 10, Aircom Premium etc. is used to eliminate potential differences (voltages) between the coax cable and the earth potential, which can occur, for example, during a thunderstorm. The grounding clamp has a solid stainless steel housing with a hinge and thus a compact structure. Installation is fast and easy because there are no loose parts and the earthing clamp can be closed with just one screw. No extra taping is needed.

### Technical Specifications

Grounding clamp type:	with stainless steel shell
Suitable cable types:	10 mm coax cables
Contact resistance:	$\leq 1 \text{ m}\Omega$
Operating temperature:	$-40^\circ\text{C} + 85^\circ\text{C}$
2011/65/EC RoHS:	Yes, compliant
Weatherproof:	Yes, environmental test according to IEC 68214
Corrosion resistant:	Yes
UV resistant:	Yes
Waterproof:	Yes, IP 68
Lightning tested:	Yes, according to MIL STD 1757

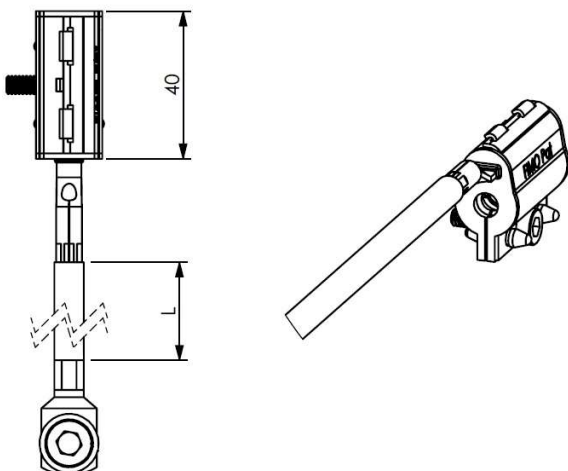

No.	Part	Material
1	Shell	Stainless steel AISI 304
2	Gasket	EPDM rubber, UV resistant
3	Inner contact	Tinned brass
4	Contact bar	Tinned brass
5	Cable	16 mm <sup>2</sup> copper, PVC isolated, black, length approx. 50 cm
6	Lug	Tinned copper, Ø 8 mm, incl. earthing screw kit
7	Hexagon head socket screw	Stainless steel VCI 5x20

### Connection instructions

Connect the earthing clamp to the equipotential busbar or earth potential using the shortest possible cable (see assembly instructions).

### Notes on environmental protection



Electrical and electronic devices must not be disposed of with household waste. These are to be handed in at a separate collection point or at the point of sale. Packaging materials must be separated and disposed of in the household waste according to the type of fabric.

### Security, warranty

The product is unsuitable for children. The packaging material and the device may contain small parts that can be swallowed. Repairs may only be carried out by specialist personnel. If you need support with technical questions or if you require service, please contact us by email: [technik@ssb-electronic.de](mailto:technik@ssb-electronic.de).

### Declaration of conformity



We hereby declare that the above Product meets all relevant regulations for the product within the scope of the directives 73/23 / EEC, 89/336 / EEC and 99/5 / EC of the Council.

Manufacturer: SSB-Electronic GmbH,  
Am Pulverhäuschen 4, 59557 Lippstadt,  
Germany

Technical changes reserved. The contents of this document are the intellectual property of SSB-Electronic GmbH. Reproduction is only permitted with express written approval.

### Contact:

E-Mail:	<a href="mailto:technik@ssb-electronic.de">technik@ssb-electronic.de</a>
Fone:	+49 (0) 2941-93385-0
Internet:	<a href="http://www.ssb-electronic.de">www.ssb-electronic.de</a>